

Globe Valves

Type 02401 - Globe Valve



Cryogenic-Globe and Globe/Check Valves, PN50

Bronze body and topwork,
 "live loaded" gland packing
 "cleaned and degreased for oxygen service"

Part No. 02401.X.0007

Part No. 02401.X.5007 Globe/Check Valve

Completed with union type butt weld fittings for stainless steel pipes
 acc. to ISO 1127 or ASTM A312

Available options - on request only:

- Valve with control disc (tapered design)
- Further pipe wall thicknesses

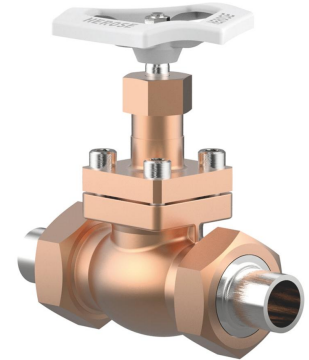

Applications:

Approved for air gases, vapours and cryogenic liquefied gases incl. LNG.

Working temperature: -196°C / -321°F (77K) up to +120°C / +248°F (393K)

Recommended working temperature: -60°C / -76°F (213K) up to +120°C / +248°F (393K)

Materials	DIN EN	ASTM
1 Body	CC491K	B 62 UNS C83600
2 Valve seal	PTFE / Carbon filled (25%)	
3 Disc	CW614N	B 283 UNS C38500
4 Bonnet gasket	PTFE	
5 Headpiece	CC493K	B 505 UNS C93200
6 Bolts	1.4301/A2 A 194 B8	
8 Stem	1.4301 A 276 Grade 304	
9 Gland packing	Graphite / PTFE	
10 Gland nut	CW614N	B 283 UNS C38500
11 Handwheel	Aluminium alloy	
12 Spring	CW452K	B 159 UNS C51900
13 Weld fitting	1.4301 A 276 Grade 304	
14 Union nut	CC493K	B 505 UNS C93200

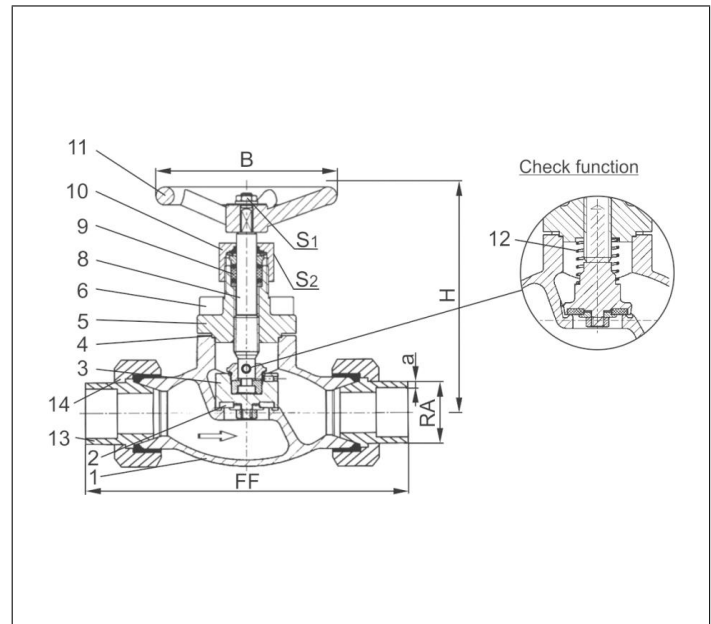

Type 02401 - Standard design	Technical data									
Nominal size	DN	10	10	15	20	25	32	40	50	
Dimension code	.X.	1012	1017	1521	2027	2533	3242	4048	5060	
Face-to-face dimension	FF	137	141	168	168	203	203	230	263	
Height	H	140	140	140	140	170	170	175	200	
Outside pipe-Ø ISO 1127	RA	12.0	17.2	21.3	26.9	33.7	42.4	48.3	60.3	
Wall thickness pipe ISO 1127	a	1.0	2.3	2.6	2.0	3.2	2.0	3.6	3.6	
Outside pipe-Ø ASTM A312	RA	-	17.15	21.34	26.67	33.40	42.16	48.26	60.33	
Wall thickness pipe ASTM A312	a	dimensions acc. to S10 or S40								
Handwheel-Ø	B	100	100	100	100	125	125	125	125	
Wrench size across flats	S ₁	7	7	7	7	7	10	10	10	
Wrench size across flats	S ₂	30	30	30	30	36	36	36	36	
Weight	ca. kg	1.2	1.2	2.4	2.4	4.0	4.0	6.3	9.5	
Kvs-Value	m ³ /h	1.6	2.2	6.7	6.7	12.1	12.1	22.6	37.1	
Cv-Value	gal/min	1.9	2.6	7.8	7.8	14.1	14.1	26.3	43.2	

Dimensions in mm.