

Globe Valves

Type 03351 - Globe Valve, ASME B16.5 Flanges



Cryogenic-Globe and Globe/Check Valves, class 300

Stainless steel body and topwork,
 "live loaded" gland packing
 "cleaned and degreased for oxygen service"

Part No. 03351.X.0003

Part No. 03351.X.5003 Globe/Check Valve

Flanged connection acc. to ASME B16.5 class 300

Available options - on request only:

- Valve with control disc (tapered design)



Applications:

Approved for air gases, vapours and cryogenic liquefied gases incl. LNG.

Working temperature: -196°C / -321°F (77K) up to +120°C / +248°F (393K)

Recommended working temperature: -60°C / -76°F (213K) up to +120°C / +248°F (393K)

Materials	DIN EN	ASTM
1 Body	1.4308	A 351 CF8
2 Valve seal up to DN50	PTFE / Carbon filled (25%)	
2a Valve seal from DN65	PTFE	
3 Disc	1.4301	A 276 Grade 304
4 Bonnet gasket	PTFE	
5 Headpiece	1.4301 / 1.4308	A 276 Grade 304 / A 351 CF8
6 Bolts	1.4301/A2	A 194 B8
8 Stem	1.4301	A 276 Grade 304
9 Gland packing	Graphite / PTFE / MICA	
10 Gland nut	1.4305	A 276 Grade 303
11 Handwheel	Aluminium alloy	
12 Spring	1.4310	A 313 Grade 301
13 Bush	CW452K	B 159 UNS C51900

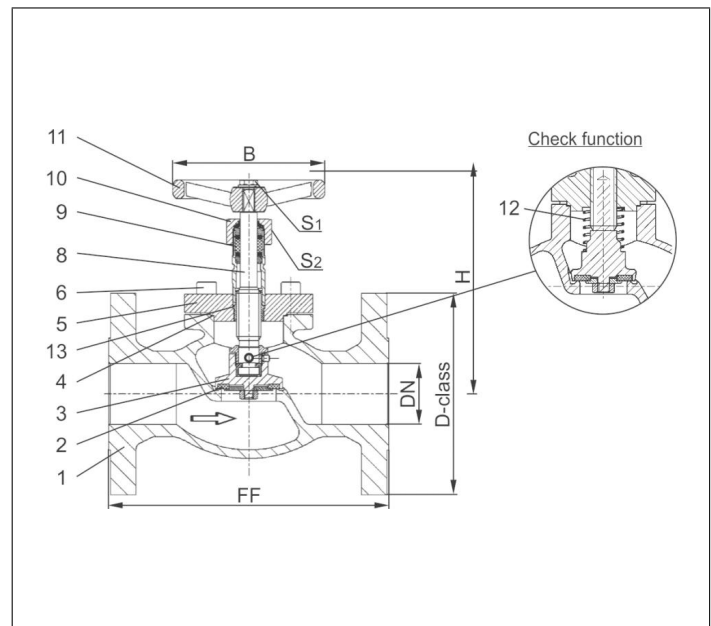

Type 03351 - Standard design	Technical data									
Nominal size	DN	15	20	25	40	50	65	80	100	150
Dimension code - Flange ASME B16.5 class 300	.X.	0400	0600	1000	1400	2000	2400	3000	4000	6000
Flange-Ø	D-class	95	115	125	155	165	190	210	255	320
Face-to-face dimension	FF	140	150	160	200	230	290	310	350	597
Height	H	130	130	140	170	200	260	310	350	380
Handwheel-Ø	B	100	100	100	125	125	200	250	315	360
Wrench size across flats	S ₁	7	7	7	10	10	10	10	12	15
Wrench size across flats	S ₂	30	30	30	36	36	36	36	41	41
Weight	ca. kg	3.0	3.5	4.5	9.0	13.0	21.0	28.0	42.0	83.0
Kvs-Value	m ³ /h	4.3	6.7	11.5	22.6	37.1	71.1	104.0	170.0	350.0
Cv-Value	gal/min	5.0	7.8	13.4	26.3	43.2	82.9	121.3	198.3	408.4

Dimensions in mm. Compliance of tightness requirements acc. to EN 1626 for DN150 up to 20 bar differential pressure. In the range of >20-40 bar, 350-700ml per second (1 bar, 20°C [68°F]) are reached.