

# Offshore Valves

## Type 03741 - Globe Valve, DIN EN Flanges



### Cryogenic-Globe and Globe/Check Valves, PN40

Stainless steel body and topwork,  
 "live loaded" gland packing  
 "cleaned and degreased for oxygen service"

**Part No. 03741.X.0012 (H = 270mm)**  
**Part No. 03741.X.0022 (H = 370mm)**  
**Part No. 03741.X.5012 (H = 270mm) Globe/Check Valve**  
**Part No. 03741.X.5022 (H = 370mm) Globe/Check Valve**  
 Flanged connection acc. to DIN EN 1092-1 PN40

Available options - on request only:  
 · Extension H up to 900mm  
 · Valve with control disc (tapered design)



### Applications:

Approved for air gases, vapours and cryogenic liquefied gases incl. LNG.  
 Working temperature: -255°C / -427°F (18K) up to +120°C / +248°F (393K)

Materials	DIN EN	ASTM
1 Body	1.4409	A 351 CF3M
2 Valve seal	PCTFE (Kel-F)	
3 Disc	1.4404	A 276 Grade 316L
4 Bonnet gasket	Graphite	
5 Headpiece	1.4404	A 276 Grade 316L
6 Bolts	1.4571/A4	similar A 194 B8T
7 Elongation tube	1.4571	A 213 TP316Ti
8 Stem	1.4404	A 276 Grade 316L
9 Gland packing	Graphite / PTFE / MICA	
10 Gland nut	1.4404	A 276 Grade 316L
11 Handwheel	1.4409	A 351 CF3M
12 Spring	1.4571	A 313 Grade 316Ti
13 Bush	CW452K	B 159 UNS C51900

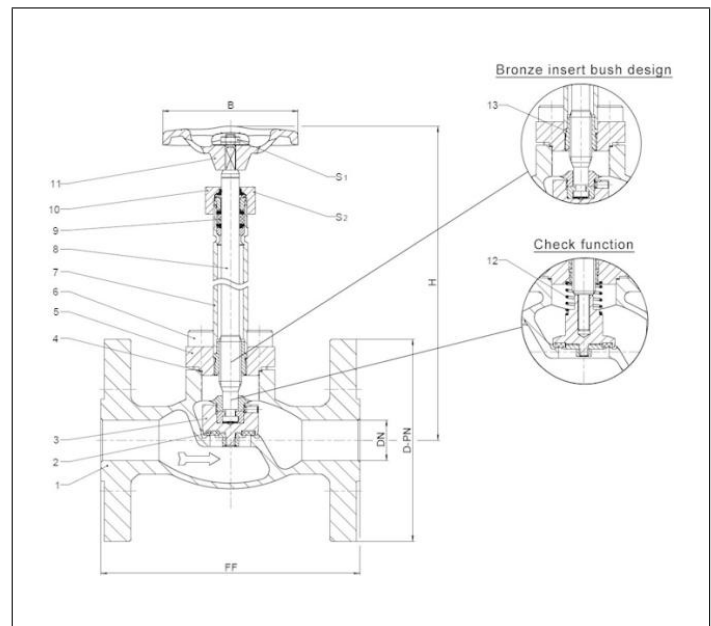

Type 03741 - Standard design	Technical data										
Nominal size	DN	15	20	25	40	50	65	80	100	150	
Dimension code - Flange EN 1092-1 PN40	.X.	0150	0200	0250	0400	0500	0650	0800	1000	1500	
Flange-Ø	D-PN	95	105	115	150	165	185	200	235	300	
Face-to-face dimension	FF	140	150	160	200	230	290	310	350	550	
Height	H	270 mm or 370 mm								370	420
Handwheel-Ø	B	100	100	100	125	125	200	250	315	360	
Wrench size across flats	S <sub>1</sub>	7	7	7	10	10	10	10	12	15	
Wrench size across flats	S <sub>2</sub>	30	30	30	36	36	36	36	41	41	
Weight	ca. kg	3.0	3.5	5.0	9.0	13.0	21.0	28.0	42.0	83.0	
Kvs-Value	m <sup>3</sup> /h	4.3	6.7	11.5	22.6	37.1	71.1	104.0	170.0	350.0	
Cv-Value	gal/min	5.0	7.8	13.4	26.3	43.2	82.9	121.3	198.3	408.4	
Stroke	mm	12	12	12	15	19	23	25	30	45	

Dimensions in mm. Compliance of tightness requirements acc. to EN 1626 for DN150 up to 20 bar differential pressure. In the range of >20-40 bar, 350-700ml per second (1 bar, 20°C [68°F]) are reached.