

Changeover Valves

Type 7111 - Diverter-Plug-Valve



Cryogenic Diverter Plug Valves, bronze, PN50

for the installation of two safety valves,
provided for bursting disc connections,
"cleaned and degreased for oxygen service"

Part No. 7111.X

Female thread connection (G) acc. to ISO 228/1 or
Female thread connection NPT acc. to ANSI B 1.20.1

Available Options - on request only:

- Inlet with union type braze or butt weld fitting
- Combination of different outlet threads GA₁ - GA₂ - GA₃

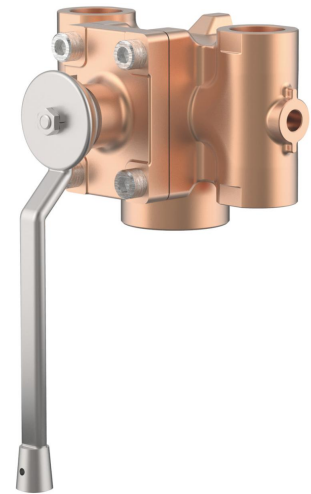

Applications:

Approved for air gases, vapours and cryogenic liquefied gases incl. LNG.

Working temperature: -196°C / -321°F (77K) up to +120°C / +248°F (393K)

For O₂-applications: Up to 60°C / 140°F (333K): maximum oxygen pressure up to 40 bar

From 60°C / 140°F (333K): maximum oxygen pressure up to 25 bar

Materials	DIN EN	ASTM
1 Body	CC491K	C83600
2 Seal	PTFE	
3 Pin	1.4301	304
4 Cock plug	CW614N	C38500
5 Upper part	CC491K	C83600
6 Stem	1.4301	304
7 Seal	PTFE	
8 Gland packing	Graphite / PTFE	
9 Disc spring	1.4310	301
10 STB screw	CW614N	C38500
11 Screw	1.4301	304
12 Lever	1.4308	CF8
13 Disc spring	1.4568	631
14 Spring	Cu	C11000

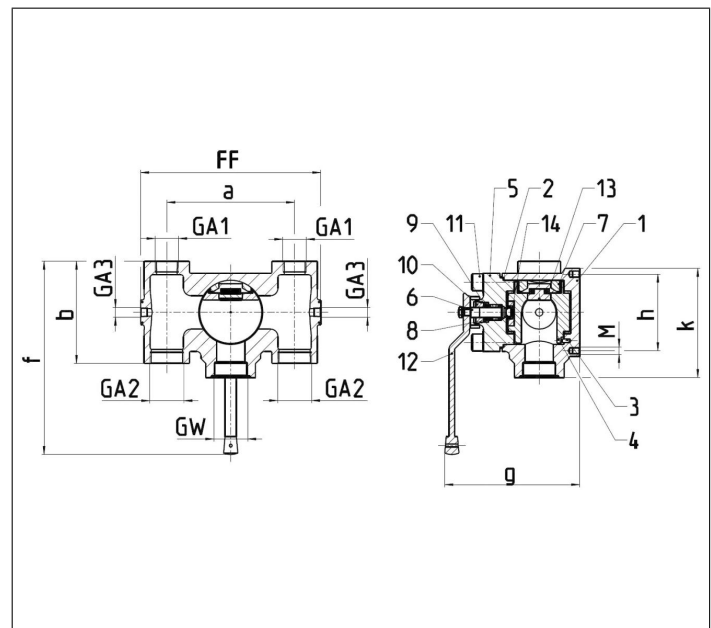

Type 7111 - Standard design	Technical Data						
Nominal Size	DN	32	32	32	32	32	32
Dimension code	.X.	FN14000. D3001	FN12000. D3002	FN10000. D3003	FG14000. D3005	FG12000. D3006	FG10000. D3007
Inlet	GW	1-1/2 NPT	1-1/4 NPT	1 NPT	1-1/2 G	1-1/4 G	1 G
Outlet	GA ₁	1	3/4	1/2	1	3/4	1/2
Outlet	GA ₂	1	3/4	1/2	1	3/4	1/2
Test connection	GA ₃	1/4	1/4	1/4	1/4	1/4	1/4
Face-to-face dimension	FF	180	180	180	180	180	180
Length	a	125	125	125	125	125	125
Height	b	94	94	94	94	94	94
Length	f	247	247	247	247	247	247
Length	g	154	154	154	154	154	154
Length	h	82	82	82	82	82	82
Length	k	113	113	113	113	113	113
Weight	ca. kg	5.6	5.6	5.6	5.6	5.6	5.6
Kvs - Value, one side open	m ³ /h	22.8	16.0	10.0	22.8	16.0	10.0
Cv - Value, one side open	gal /min	26.5	18.6	11.6	26.5	18.6	11.6
Kvs - Value, both sides open	m ³ /h	43.7	33.0	20.0	43.7	33.0	20.0
Cv - Value, both sides open	gal /min	50.8	38.4	23.3	50.8	38.4	23.3

Dimensions in mm.

Changeover Valves

Type 7111 - Diverter-Plug-Valve



Type 7111 - Standard design		Technical Data			
Nominal Size	DN	50	50	50	50
Dimension code	.X.	FN14000. D5001	FN20000. D5004	FG14000. D5009	FG20000. D5008
Inlet	GW	1-1/2 NPT	2 NPT	1-1/2 G	2 G
Outlet	GA ₁	1	1-1/2	1	1-1/2
Outlet	GA ₂	1	1-1/2	1	1-1/2
Test connection	GA ₃	1/4	1/4	1/4	1/4
Face-to-face dimension	FF	254	254	254	254
Length	a	180	180	180	180
Height	b	144	144	144	144
Length	f	272	272	272	272
Length	g	190	190	190	190
Length	h	108	108	108	108
Length	k	124	124	124	124
Weight	ca. kg	16.9	16.9	16.9	16.9
Kvs - Value, one side open	m ³ /h	25.3	49.5	25.3	49.5
Cv - Value, one side open	gal /min	29.3	57.4	29.3	57.4
Kvs - Value, both sides open	m ³ /h	47.0	114.0	47.0	114.0
Cv - Value, both sides open	gal /min	54.5	132.2	54.5	132.2

Dimensions in mm.

Spare Parts Diverter-Plug-Valve:

Spare Part Kit Cock Plug Seal DN32

Part No. 30003.0002.0000

Spare Part Kit Cock Plug Seal DN50

Part No. 30003.0002.0001

Spare Part Kit Gland Packing DN32/DN50

Part No. 30003.0001.0000